

Workspace Mounting Solutions

Atdec price-list for





Set & Forget

desk mounting solutions

The performance and design leaders
in non-dynamic arms category



AF-AT-P mount with
AF-AN-P accessory arm



AF-AT-B

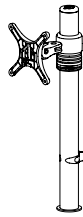

440mm post with 124mm arm			
Code	Colour	Qty	Price
AF-M-P	Polished	1-20	
		21- 100	
		101-300	
		301-1000	
up to 8kg up to 34"			

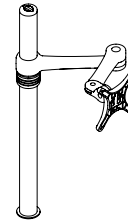

525mm post with 422mm arm			
Code	Colour	Qty	Price
AF-AT-P	Polished	1-20	
AF-AT-B	Black	21- 100	
AF-AT-SW	White	101-300	
		301-1000	
up to 8kg up to 34"			

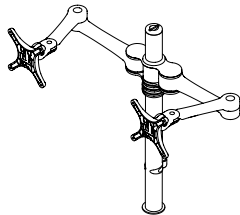

440mm post with two 476mm arms			
Code	Colour	Qty	Price
AF-AT-D-P	Polished	1-20	
		21- 100	
		101-300	
AF-AT-D-B	Black	101-300	
		301-1000	
up to 8kg per display up to 27"			

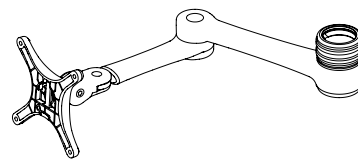

422mm monitor arm accessory			
Code	Colour	Qty	Price
AF-AA-P	Polished	1-20	
AF-AA-B	Black	21- 100	
AF-AA-SW	White	101-300	
		301-1000	
up to 8kg			

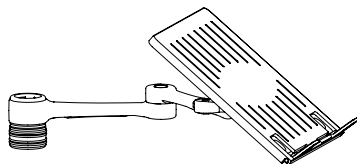

422mm notebook arm accessory			
Code	Colour	Qty	Price
AF-AN-P	Polished	1-20	
AF-AN-B	Black	21- 100	
AF-AN-SW	White	101-300	
		301-1000	
up to 8kg Notebooks up to 18"			

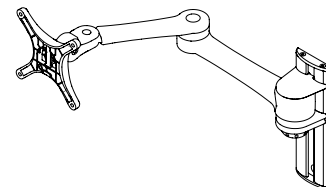

463mm arm wall mount			
Code	Colour	Qty	Price
AF-AT-W-P	Polished	1-20	
		21- 100	
		101-300	
		301-1000	
up to 8kg up to 34"			

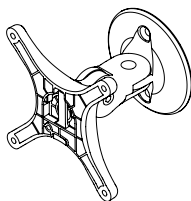

100mm arm wall mount			
Code	Colour	Qty	Price
AF-WD-P	Polished	1-20	
		21- 100	
		101-300	
		301-1000	
up to 8kg up to 34"			

Set & Forget mounts are ideal for:

- fixed desk heights
- less frequent display height adjustment



Set & Forget freestanding mounting solutions

Ideal for temporary arrangements
and hot-desking



VFS-DV



VFS-DH



Dual horizontal desk stand

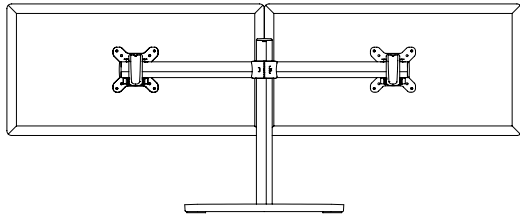

Code	Colour	Price
VFS-DH	Silver	

up to 12kg per display up to 27"

Dual vertical desk stand

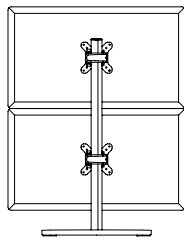

Code	Colour	Price
VFS-DV	Silver	

up to 12kg per display up to 27"

Quad desk stand

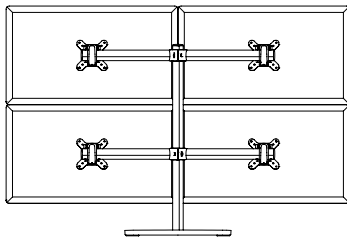

Code	Colour	Price
VFS-Q	Silver	

up to 12kg per display up to 27"

Triple desk stand (bolt through mounting kit included)

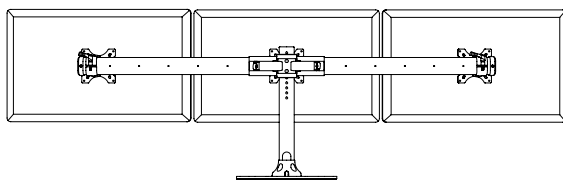

Code	Colour	Price
SD-FS-T	Black	

up to 8kg per display up to 24"

Hex desk stand (bolt through mounting kit included)

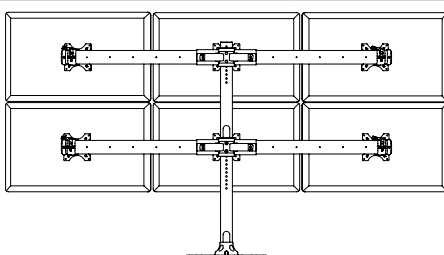

Code	Colour	Price
SD-FS-H	Black	

up to 8kg per display up to 24"



Atdec Workspace Modular mounts

World's most configurable display mounting system



Custom solutions
Infinite configurations
Cost effective upgrades



Select the optimum combination of arms and posts

A mix of various height posts and arm lengths are available to create custom solutions to your specific project requirements.

Choose your colour

A range of colour options are available for all components.



Consider future upgrades

The flexible modular design will future proof your investment and ensure efficient upgrades and reconfigurations as your business grows.

The four channel post design allows for future upgrades and re-arrangements.



Modular desk mounting solutions

Dynamic arm monitor desk mount

AWMS-DB

- Ideal for sit-to stand desk and agile spaces
- Effortless movement
- Available in silver, black or white finish
- Choice of mounting options

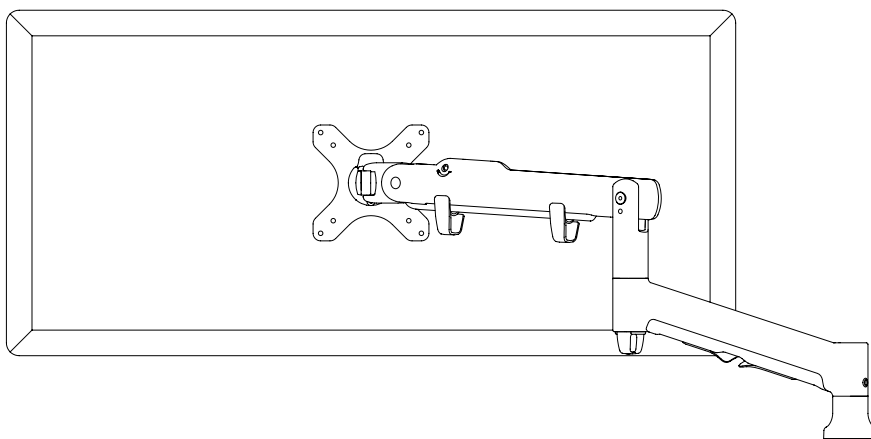

Spring-assisted arm

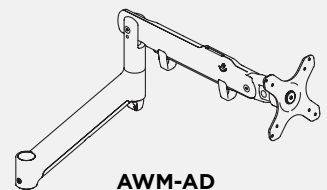

AWM-AD
Up to 9kg

Add the desk base



AWM-LB

Choose your desk fixing option



Bolt through
AWM-FB

Offers flexibility in mounting position & when attachment to the edge of the desk is not possible.

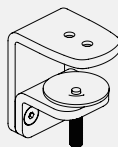

F-clamp
AWM-FF

Traditional two piece design. Better for retrofit and thicker desks up to 79mm.

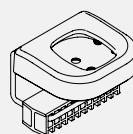

C-clamp
AWM-FC

Compact design to avoid potential interference with the elements under the desk such as cable cages. Easy top-mounting installation.

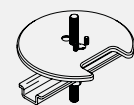

Grommet clamp
AC-GC

Utilises an existing grommet hole and allows for neater cable management. Fits grommet holes 60-80mm in diameter.



Build your own configuration

Choose your arm

Non-dynamic arms

Ideal for set & forget configurations where displays do not require frequent height adjustment or in applications with a fixed desk height and single user environments.



0-12kg
130mm arm
AWM-A13

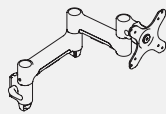

0-12kg
460mm arm
AWM-A46



0-9kg
710mm arm
AWM-A71

Clamp included
AWM-LC

Dynamic arms

Spring-assisted design allows for quick and easy display height and focal distance adjustment from a seated position. Ideal for agile spaces and sit-to-stand desks environments.

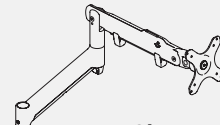

Up to 9kg
618mm dynamic arm
AWM-AD



Add clamp
AWM-LC

Choose your post or wall mount

Desk

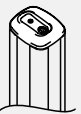

135mm
post
AWM-P13

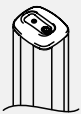

400mm
post
AWM-P40

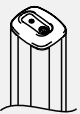

750mm
post
AWM-P75

Wall



350mm
wall channel
AWM-W35



60mm
wall channel
AWM-W6

Choose your desk fixing option



Bolt through
AWM-FB

Offers flexibility in mounting position & when attachment to the edge of the desk is not possible.

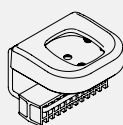

C-clamp
AWM-FC

Compact design to avoid potential interference with the elements under the desk such as cable cages. Easy top-mounting installation.

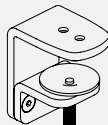

F-clamp
AWM-FF

Traditional two piece design. Better for retrofit and thicker desks up to 79mm.

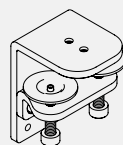

Dual plate F-clamp
AWM-FH

Recommended for all 750mm post solutions and other set ups with extra heavy screens.

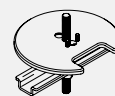

Grommet clamp
AWM-GC

Utilises an existing grommet hole and allows for neater cable management. Fits grommet holes 60-80mm in diameter.

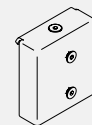

Slat wall adaptor
AWM-WS

Atdec Workplace Modular series

Choosing the post

135mm post

AWM-P13 is exclusively used with dynamic arms and allows for upgrades to a dual display solution.



400mm post

AWM-P40 will accommodate most single, dual or triple display configurations mounted in one row.

750mm post

AWM-P75 is required when mounting displays in two rows or when extra height is required for single, dual or triple configurations.



Desk fixing options (order separately)

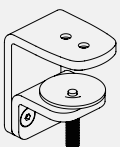

F-clamp AWM-FF

Traditional two piece design. Better for retrofit and thicker desks up to 79mm.

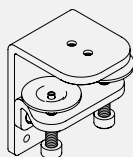

Dual plate F-clamp AWM-FH

Recommended for all 750mm post solutions and other set ups with extra heavy screens.



Bolt through AWM-FB

Offers flexibility in mounting position & when attachment to the edge of the desk is not possible.

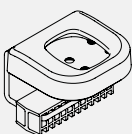

C-clamp AWM-FC

Compact design to avoid potential interference with the elements under the desk such as cable cages. Easy top-mounting installation.

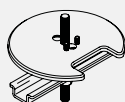

Grommet clamp AC-GC

Utilises an existing grommet hole and allows for neater cable management. Fits grommet holes 60-80mm in diameter. The edge of the desk is not possible.



Accessories

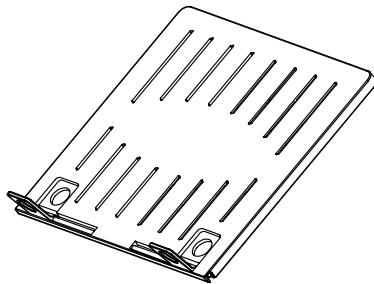

Notebook tray

SNTB

Suitable to notebooks up to 18".
Replaces VESA monitor head on the AWM arms when a notebook support is required.

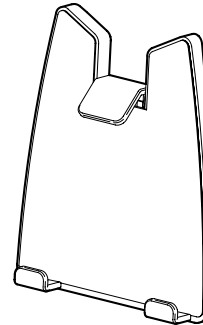

Universal tablet holder

AC-AP-UTH

Attaches to any 100 x 100 VESA mounting head and is compatible with a wide range of tablet devices.

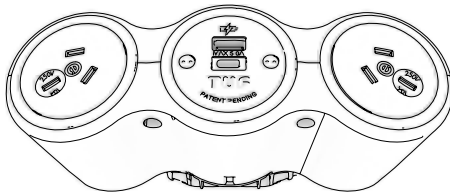

Intelligent power module

APM

Fast charge USB type A and type C.
Compatible with AF- and AWM- series desk mounts. Removable cartridge for future USB upgrades.

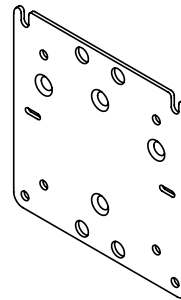

Mini PC mounting plate

AC-MP

Elevates mini PC from the desk.
Attaches directly to any AF- or AWM-post and is compatible with a wide range of small form factor PCs.

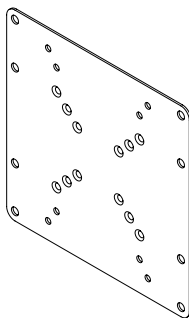

200 x 200 VESA adaptor plate

AC-AP-2020

For monitors with VESA mounting hole configurations larger than the common 50 x 50mm, 75 x 75mm or 100 x 100mm.

Atdec Uncover™ tip

Turbocharge your workstations with accessories

- > Above-desk charging stations
- > Adjustable laptop holders
- > Universal tablet adaptors

Modular desk mounting solutions

Popular solutions



Dynamic arm desk mount

AWMS-DB

Parts required*

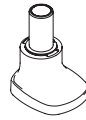

AWM-LB

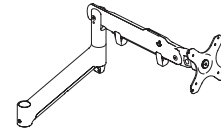

AWM-AD



2 x AWMS-DB mounts can be positioned apart to achieve greater range of movement and optimal focal distance.

* Add desk fixing of your choice



up to 9kg



up to 34"



Dynamic arm on 135mm post

AWMS-D13

Parts required*

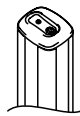

AWM-P13



AWM-LC

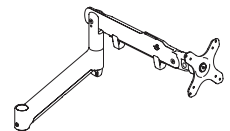

AWM-AD

* Add desk fixing of your choice



up to 9kg



up to 34"



2 x dynamic arms on 135mm post

AWMS-2-D13

Parts required*

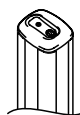

AWM-P13



**AWM-LC
X2**

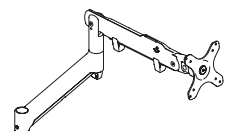

**AWM-AD
x2**

* Add desk fixing of your choice



up to 9kg



up to 34"



Popular solutions



2 x dynamic arms (notebook combo) on 135mm post

ADMS-2-ND13

Parts required*

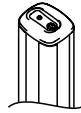

AWM-P13



AWM-LC X2

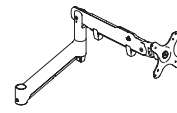

AWM-AD x2

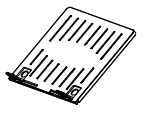

SNTB

* Add desk fixing of your choice



up to 9kg



up to 34"



2 x dynamic arms on 400mm post

AWMS-2-D40

Parts required*

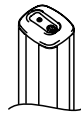

AWM-P40



AWM-LC X2

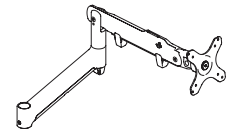

AWM-AD x2

* Add desk fixing of your choice



up to 9kg



up to 24"



Dynamic arm on 400mm post

AWMS-D40

Parts required*

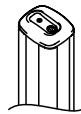

AWM-P40



AWM-LC

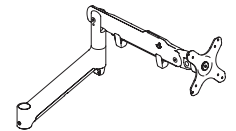

AWM-AD

* Add desk fixing of your choice



up to 9kg



up to 34"

Choose your desk fixing option (order separately)



Bolt through
AWM-FB

Offers flexibility in mounting position & when attachment to the edge of the desk is not possible.

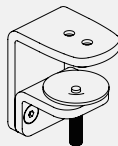

F-clamp
AWM-FF

Traditional two piece design. Better for retrofit and thicker desks up to 79mm.

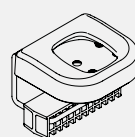

C-clamp
AWM-FC

Compact design to avoid potential interference with the elements under the desk such as cable cages. Easy top-mounting installation.

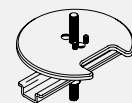

Grommet clamp
AC-GC

Utilises an existing grommet hole and allows for neater cable management. Fits grommet holes 60-80mm in diameter.

Modular desk mounting solutions

Popular solutions



460mm arm on 400mm post

AWMS-4640

Parts required*

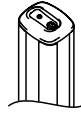

AWM-P40

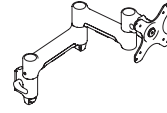

AWM-A46

* Add desk fixing of your choice



up to 12kg



up to 43"



2 x 460mm arms on 400mm post

AWMS-2-4640

Parts required*

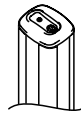

AWM-P40

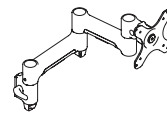

**AWM-A46
X2**

* Add desk fixing of your choice



up to 12kg



up to 30"



3 arms on 400mm post

AWMS-3-137140

Parts required*

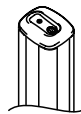

AWM-P40

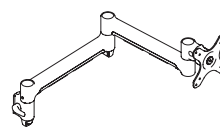

**AWM-A71
X2**

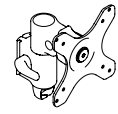

AWM-A13

* Add desk fixing of your choice



up to 9kg



up to 24"

Choose your desk fixing option (order separately)



**Bolt through
AWM-FB**

Offers flexibility in mounting position & when attachment to the edge of the desk is not possible.

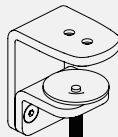

**F-clamp
AWM-FF**

Traditional two piece design. Better for retrofit and thicker desks up to 79mm.

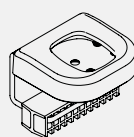

**C-clamp
AWM-FC**

Compact design to avoid potential interference with the elements under the desk such as cable cages. Easy top-mounting installation.

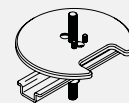

**Grommet clamp
AC-GC**

Utilises an existing grommet hole and allows for neater cable management. Fits grommet holes 60-80mm in diameter.



Popular solutions



4 x 460mm arms on 750mm post

AWMS-4-4675

Parts required*

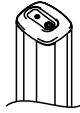

AWM-P75

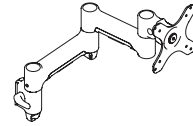

**AWM-A46
X4**

* Add desk fixing of your choice



up to 12kg



up to 30"

Choose your desk fixing option (order separately)

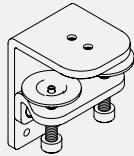

**Dual plate F-clamp
AWM-FH**

Recommended for all 750mm post solutions and other set ups with extra heavy screens.

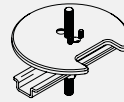

**Grommet clamp
AC-GC**

Utilises an existing grommet hole and allows for neater cable management. Fits grommet holes 60-80mm in diameter.



Modular desk mounting solutions

Modular desk mounting

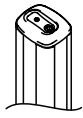

135mm post

Code	Colour	Qty	Price
AWM-P13-S	Silver	1-20	
AWM-P13-B	Black	21- 100	
AWM-P13-W	White	101-300	
		301-1000	

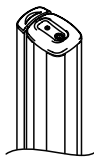

400mm post

Code	Colour	Qty	Price
AWM-P40-S	Silver	1-20	
AWM-P40-B	Black	21- 100	
AWM-P40-W	White	101-300	
		301-1000	

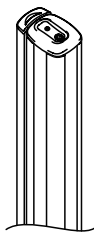

750mm post

Code	Colour	Qty	Price
AWM-P75-S	Silver	1-20	
AWM-P75-B	Black	21- 100	
AWM-P75-W	White	101-300	
		301-1000	

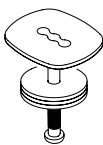

Bolt through desk fixing

Code	Colour	Qty	Price
AWM-FB-S	Silver	1-20	
AWM-FB-B	Black	21- 100	
		101-300	
		301-1000	

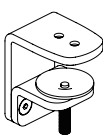

F-clamp desk fixing

Code	Colour	Qty	Price
AWM-FF-S	Silver	1-20	
AWM-FF-B	Black	21- 100	
		101-300	
		301-1000	



Modular desk mounting

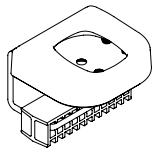

C-clamp desk fixing

Code	Colour	Qty	Price
		1-20	
AWM-FC-S	Silver	21- 100	
AWM-FC-B	Black	101-300	
AWM-FC-W	White	301-1000	

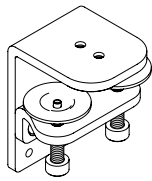

Heavy duty dual plate F-clamp

Code	Colour	Qty	Price
		1-20	
AWM-FH-S	Silver	21- 100	
AWM-FH-B	Black	101-300	
		301-1000	

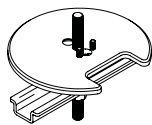

Grommet clamp

Code	Colour	Qty	Price
		1-20	
AC-GC-S	Silver	21- 100	
AC-GC-B	Black	101-300	
		301-1000	

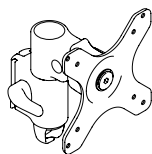

130mm arm

 up to 12kg

Code	Colour	Qty	Price
		1-20	
AWM-A13-B	Black	21- 100	
AWM-A13-S	Silver	101-300	
AWM-A13-W	White	301-1000	

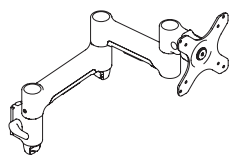

460mm arm

 up to 12kg

Code	Colour	Qty	Price
		1-20	
AWM-A46-B	Black	21- 100	
AWM-A46-S	Silver	101-300	
AWM-A46-W	White	301-1000	

Modular desk mounting solutions

Modular desk mounting

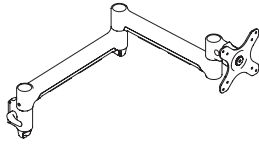

710mm arm

 up to 9kg

Code	Colour	Qty	Price
AWM-A71-B	Black	1-20	
AWM-A71-S	Silver	21- 100	
AWM-A71-W	White	101-300	
		301-1000	

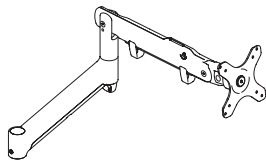

618mm dynamic arm

(requires post clamp or desk base, sold separately)

 up to 9kg

Code	Colour	Qty	Price
AWM-AD-B	Black	1-20	
AWM-AD-S	Silver	21- 100	
AWM-AD-W	White	101-300	
		301-1000	

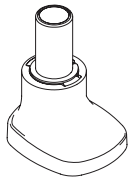

Desk base for AWM-AD

Code	Colour	Qty	Price
AWM-LB-S	Silver	1-20	
AWM-LB-B	Black	21- 100	
AWM-LB-W	White	101-300	
		301-1000	

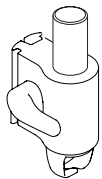

Post/wall channel clamp for AWM-AD

Code	Colour	Qty	Price
AWM-LC-S	Silver	1-20	
AWM-LC-B	Black	21- 100	
AWM-LC-W	White	101-300	
		301-1000	



350mm wall channel

Code	Colour	Qty	Price
AWM-W35-S	Silver	1-20	
AWM-W35-B	Black	21- 100	
		101-300	
		301-1000	



Modular desk mounting

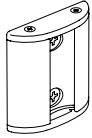

60mm wall channel

Code	Colour	Qty	Price
		1-20	
AWM-W6-S	Silver	21- 100	
AWM-W6-B	Black	101-300	
		301-1000	

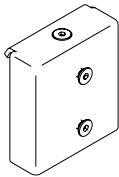

Slat wall adaptor plate

Code	Colour	Qty	Price
		1-20	
AWM-WS-S	Silver	21- 100	
		101-300	
		301-1000	

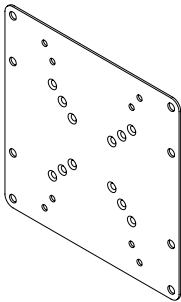

200x200 VESA adaptor plate

Code	Colour	Qty	Price
		1-20	
AC-AP-2020	Black	21- 100	
		101-300	
		301-1000	

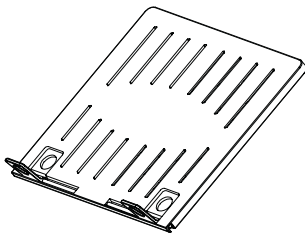

Notebook tray

Code	Colour	Qty	Price
		1-20	
SNTB	Black	21- 100	
		101-300	
		301-1000	

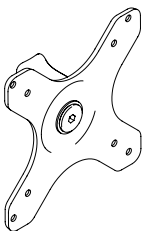

Quick release VESA monitor head

Code	Colour	Qty	Price
		1-20	
AWM-HV-S	Silver	21- 100	
AWM-HV-B	Black	101-300	
		301-1000	

Modular desk mounting solutions

Modular desk mounting

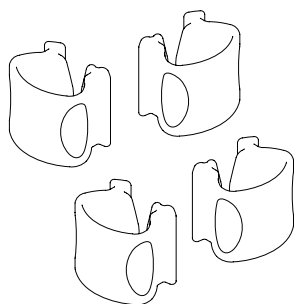

Cable clips

Code	Colour	Qty	Price
		1-20	
SC4S	Silver	21- 100	
SC4B	Black	101-300	
		301-1000	

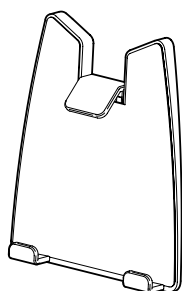

Universal tablet holder

Code	Colour	Qty	Price
		1-20	
AC-AP-UTH	Black	21- 100	
		101-300	
		301-1000	

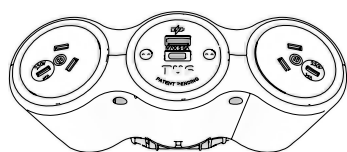

Intelligent power module

Code	Colour	Qty	Price
		1-20	
Custom	Silver	21- 100	
	Black	101-300	
	White	301-1000	

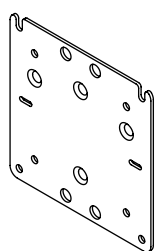

Mini PC mounting plate

Code	Colour	Qty	Price
		1-20	
AC-MP	Black	21- 100	
		101-300	
		301-1000	

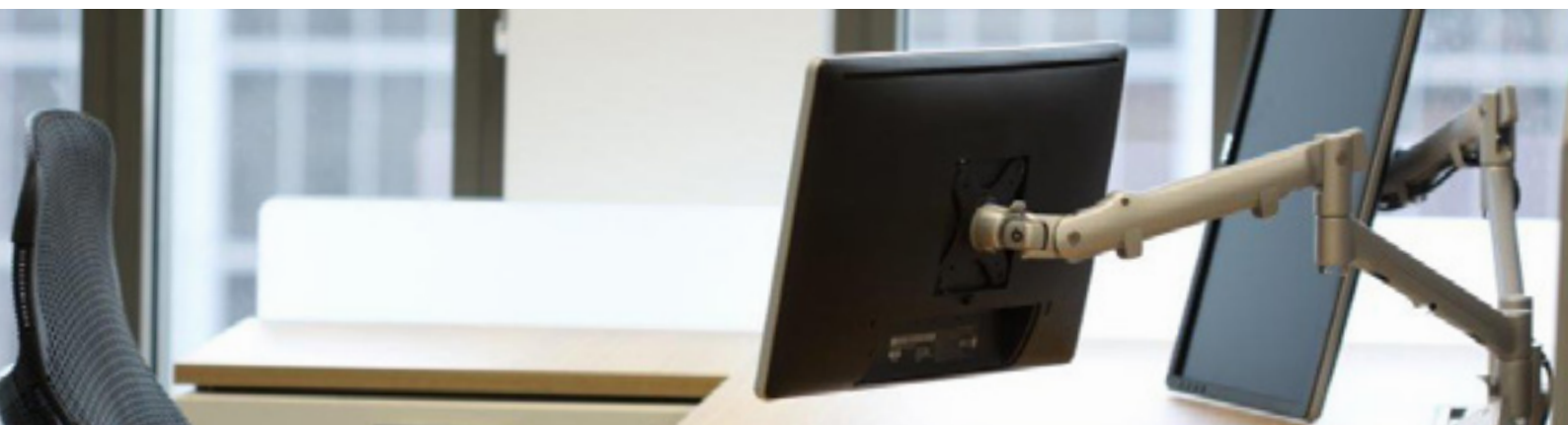



Terms and Conditions

Payment terms:

30 days net from date of invoice for Account holders.

Prices:

Prices quoted are ex GST except for RRP which is GST inclusive, ex Warehouse location, and are in Australian Dollars. All invoicing will be direct from Atdec Pty Ltd.

Ordering:

Orders will not proceed if there is a pricing discrepancy, a revised PO or written approval of price change is required for order to proceed. Order cut-off for processing is 10.00 a.m. Mon - Friday, for PM despatch for delivery from next working day. Order collect/pickup - An Atdec staff member will contact customer to advise when order is available for collection.

Product:

Not all items are guaranteed to be in stock, lead-time will be advised for any out of stock lines.

Cancellations:

If an order has already been despatched, upon return a 20% charge is applicable. Freight is non-refundable.

Returns:

All returns must be approved by Atdec in writing. Email: returns@atdec.com Any returns not approved by Atdec will be rejected at warehouse & returned to sender. A Returns Authorisation (RA#) must be obtained for approved returns. All products returned must be in a saleable condition for a refund to be issued. Returns may incur up to a 25% re-stocking fee. Freight is non-refundable.

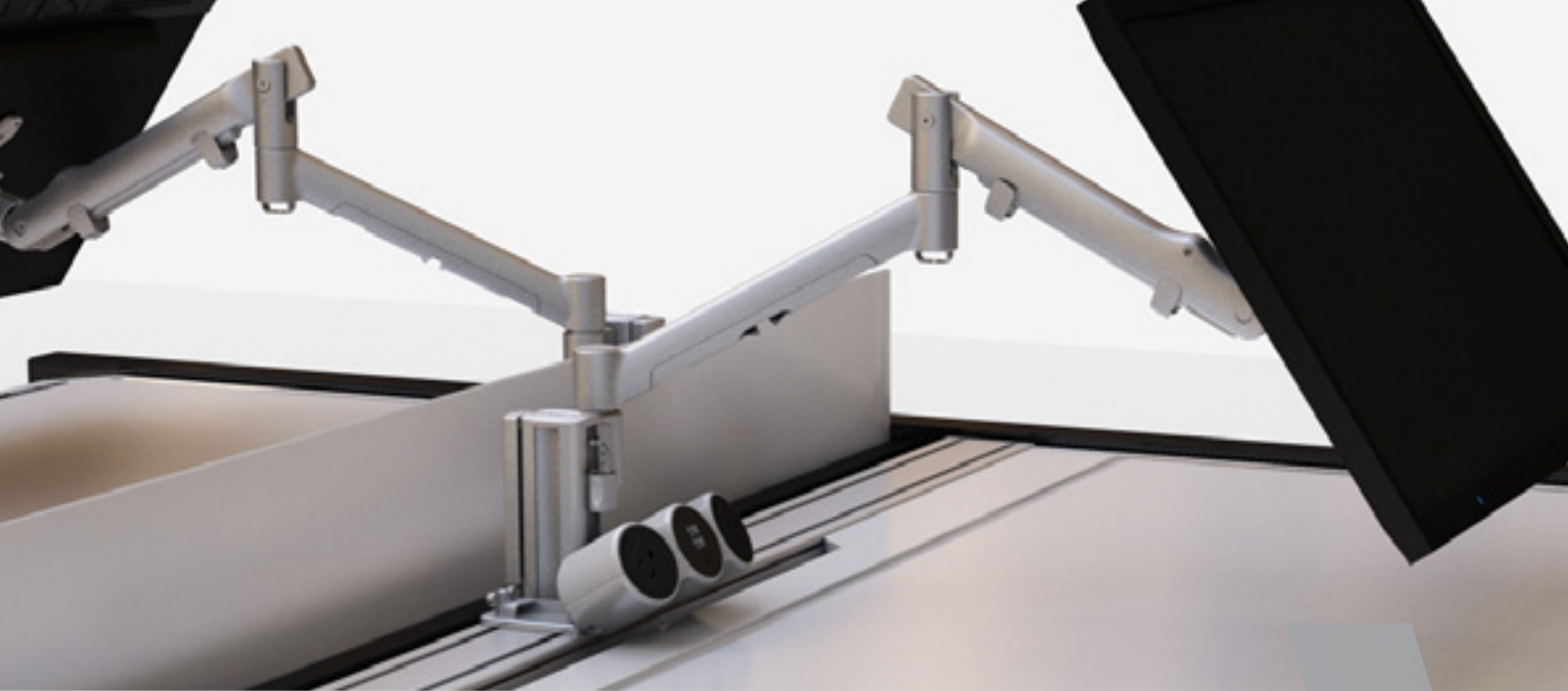

Contact us today

To schedule your complimentary Atdec Uncover™ diagnostic and select the optimum workspace solutions for your specific project.

ATDEC
Uncover 

Our complimentary diagnostic service

ATDEC
Installation Assistance 

Training & assisting professional installers

ATDEC
Bespoke 

Work with our engineers to create your bespoke solution

Supporting the best and the brightest in the world

WELLS
FARGO

Deloitte.

UNITED 

citibank

BBC

Regatta 
GREAT OUTDOORS®

Google

CommonwealthBank 

Atdec Pty Ltd ABN: 16 085 512 358

Suite 3 Level 2 16 Giffnock Avenue
Macquarie Park NSW 2113 Australia

Phone: +61 2 8729 5000
Email: info@atdec.com

atdec.com.au